

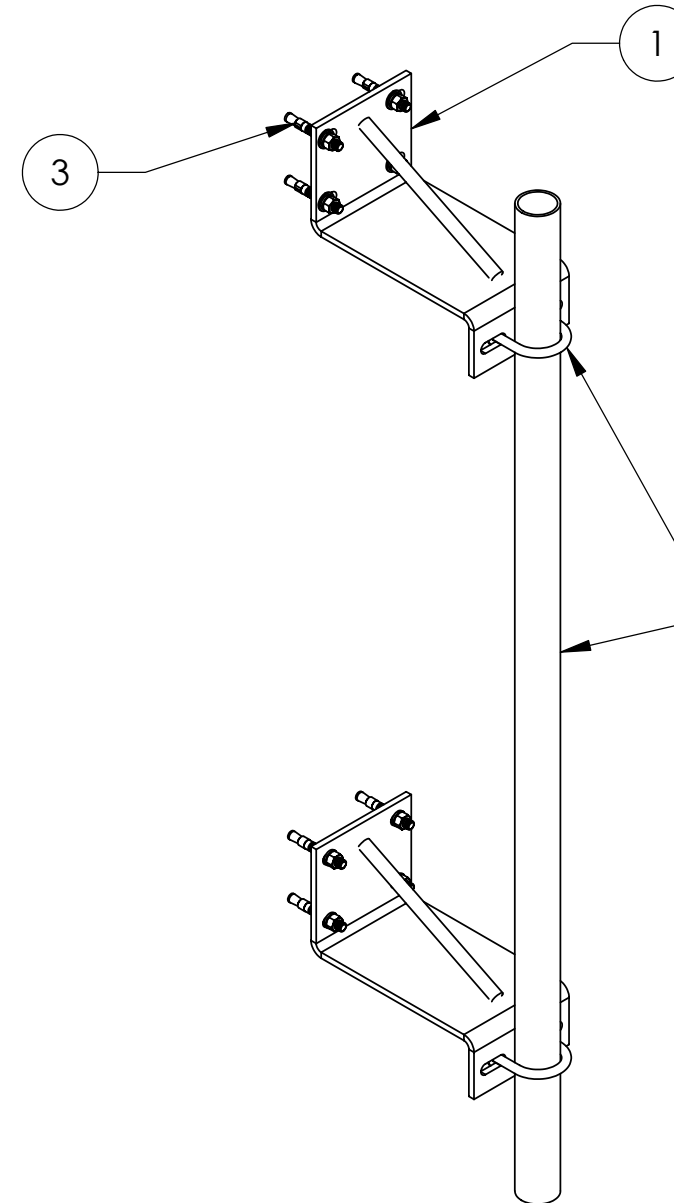

ITEM	PART NO.	DESCRIPTION	QTY.	WEIGHT
1	MT221L.04	12" WALL MOUNT BRACKET	2	16.62 LBS
2	MT222H	HARDWARE KIT (ITEM 3)	2	
3	MT-271	1/2" X 3-3/4" WEDGE ANCHOR KIT	8	0.18 LBS

REVISIONS				
REV.	ZONE	DESCRIPTION	BY	DATE
B		UPDATE ITEM 1	ACG	02/29/05
C		UPDATE ITEM 1 AND TOTAL WEIGHT	ACG	01/12/06
D		UPDATE DESCRIPTION	ACG	11/29/06
E		REDESIGN ITEM #1	MSM	02/27/08

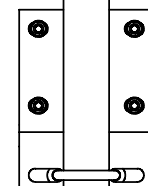
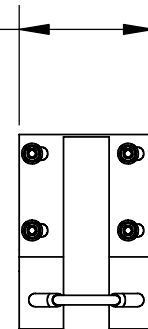
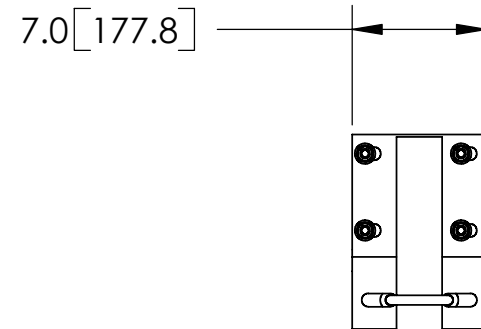
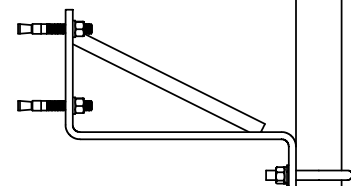
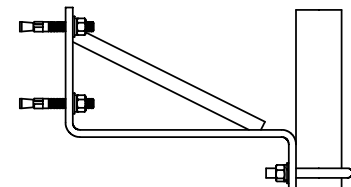
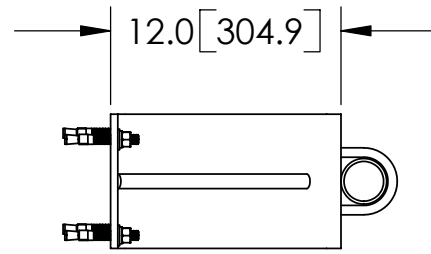

NOTE: GALV. PIPE AND U-BOLTS ORDERED SEPARATELY

These drawings and specifications are the proprietary property of ANDREW CORPORATION and may be used only for the specific purpose authorized in writing by Andrew Corporation.  ALL DIMENSIONS ARE IN INCHES U.O.S. TOLERANCES UNLESS OTHERWISE SPECIFIED: .X = ± .06      ANGLES      ±2° .XX = ± .03      FRACTIONS      ±1/32 .XXX = ± .010  REMOVE BURRS AND BREAK EDGES .005  DO NOT SCALE THIS PRINT	DRAWN BY: ACG	SHEET: 1 of 1	PART NUMBER: MT-222L
	CHECKED BY: TP	SCALE: NTS	DESCRIPTION: 12" ADJUSTABLE SOLID WALL MOUNT
	DATE: 02/09/05	MATERIAL: A36	DRAWING TYPE: ASSEMBLY DRAWING
	REVISION: E	FINISH: GALV A123	WEIGHT: 55.75 LBS



ORLAND PARK, IL. 60462 U.S.A.