

1 GENERAL

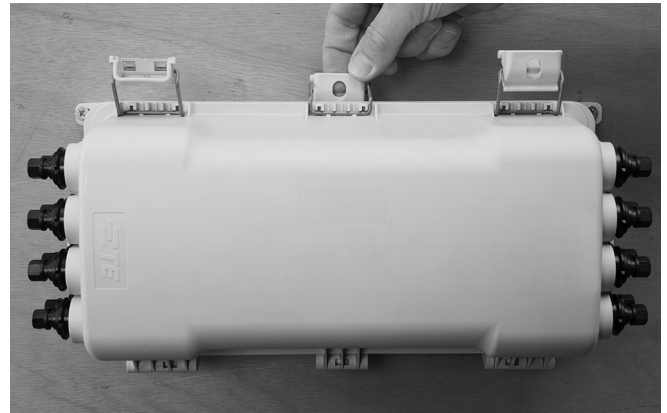

1.1 Kit Content



1.3 Open the closure releasing the five latches: three at the front and two on the sides.



1.2 Use the template to mark the drill holes.

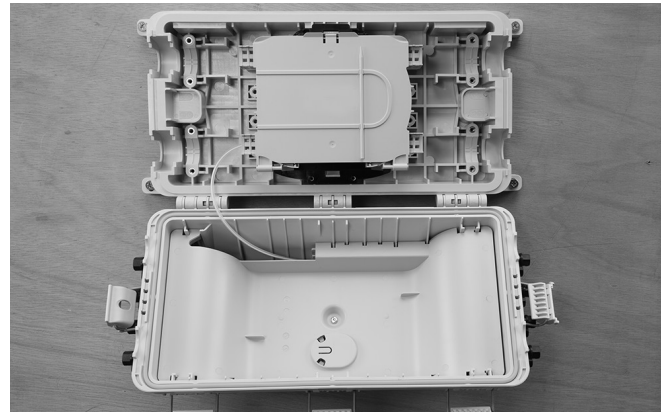

1.4 Closure in open position.

2 USE OF TRAYS

TRAY 4: Splice in line and segregation of other tubes
TRAY 3: Splice in line and segregation of other tubes
TRAY 2: Splice in line and segregation of other tubes
TRAY 1: Feeder splitter fiber - feeder tube fibers (active + reserve)

3 FEEDER CABLES

3.1 Feeder cable – (P)KP / TKT Ø 13-16 mm (Ø 0.51"-0.63")

Cable zone(mm)	Cable type	Securing the cables	Sealing	
Zone 1 Ø 16.5-15.2 (Ø 0.65"-0.60")	PKP-64FO			
Zone 2 Ø 15.1-13.6 (Ø 0.59"-0.54")	TKT-64FO PKP-32FO PKP-16FO PKP-8FO			L = 85 mm (3.35 inch)

Please use this overview for the use of the different components according to the different cable ranges.

3.2 Feeder cable – (P)KP / TKT Ø 10-13 mm (Ø 0.39"-0.51")

Cable zone(mm)	Cable type	Securing the cables	Sealing	
Zone 3 Ø 13.5-12.6 (Ø 0.53"-0.50")	TKT-32FO TKT-16FO		Length of the silicone foam strip: 	L = 105 mm (4.13 inch)
Zone 4 Ø 12.5-11.6 (Ø 0.49"-0.46")	KP-64FO KP-32FO KT-64FO KT-32FO			L = 135 mm (5.35 inch)
Zone 5 Ø 11.5-10.6 (Ø 0.45"-0.42")	KP-16FO KT-16FO			L = 155 mm (6.10 inch)
Zone 6 Ø 10.5-9.6 (Ø 0.41"-0.38")				L = 170 mm (6.69 inch)

Please use this overview table for the use of the different components according to the different cable ranges.

3.3 Installation procedure



3.3.1 Make a window cut of 2 m (78.75 inch) in the cable (make sure the oscillation point is in the middle), cut the strength member as short as possible and make a 10 cm (4 inch) long ponytail with the aramid yarn.

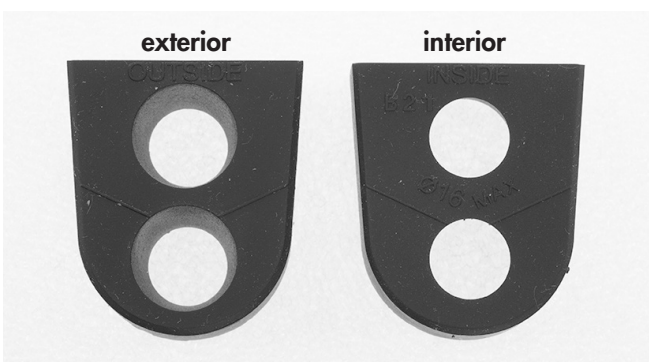

3.3.2 Two rubber seals are needed to install the feeder cable. The orientation of the seal is important.



3.3.3 Cut the lower ring of the seal along the line marked. When installing the rubber seal in the closure, the cut must always face the inside of the closure.

3.3.4 Please use the overview table (page 2) for the use of the different components according to the different cable ranges.



Silicone foam strip and measuring tape.

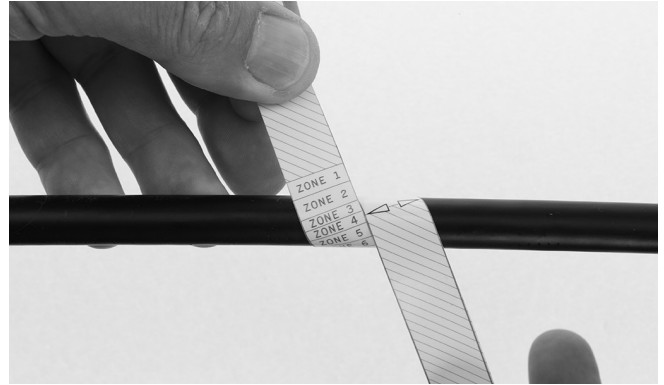

Define the appropriate zone by using the measuring tape around the cable.

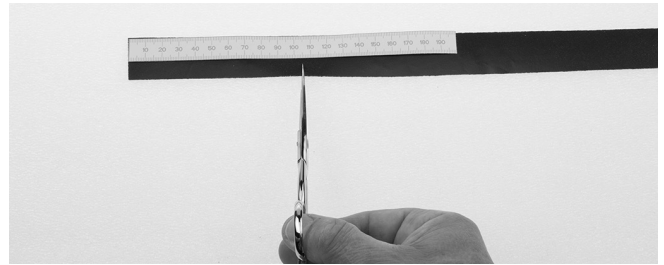

Use the table to define the correct length for the silicone foam strip to tape up the cable.



Remove the plastic protector from the silicon foam strip.

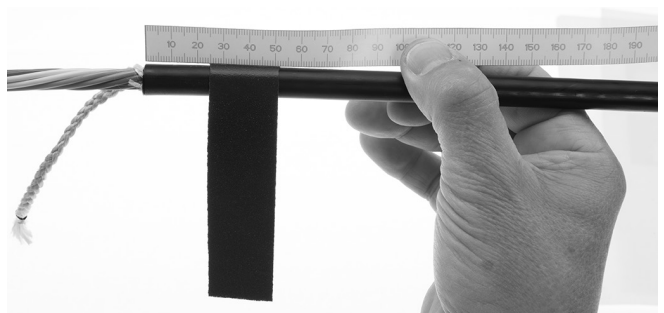

Attach the foam strip at 25 mm (1 inch) from the end of the cover.



Roll to complete.



Apply grease to the entire surface

3.3.5 Install the rubber seal as shown in the image. Check the orientation of the seal! Lubricate all of the sides of the seal and the port before inserting it into the port of the closure.

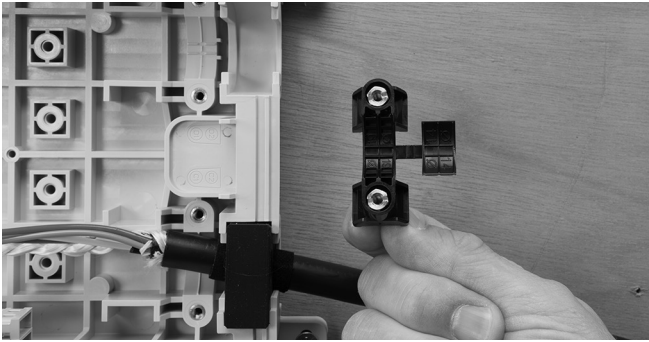

3.3.6 Lead the cable(s), with the rubber seal, to the port as shown in the image. Prepare the plastic bridge to secure the cable.

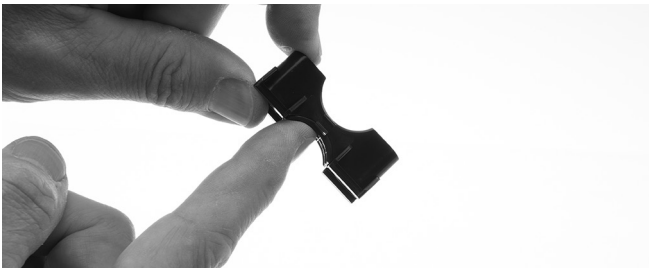
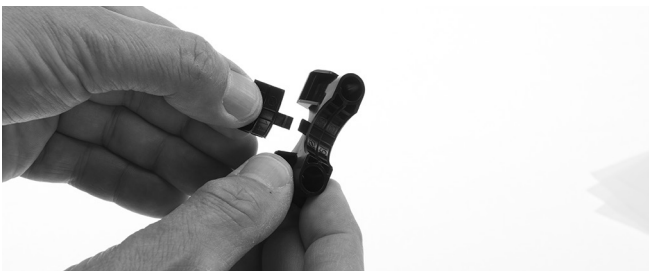

3.3.7 Depending on the diameter of the cable (see table page 2), remove the plastic shell or install it in the plastic bridge.

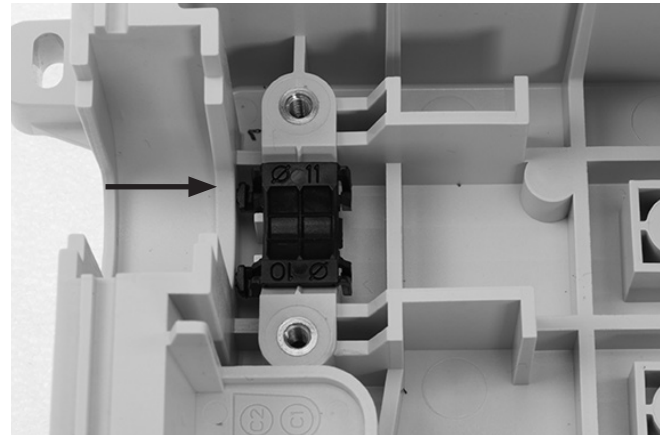
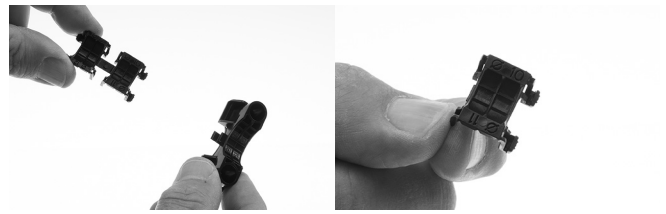

3.3.8 Depending on the diameter of the cable (see table page 2), the appropriate plastic part must be installed as shown. The orientation of the plastic part is important!

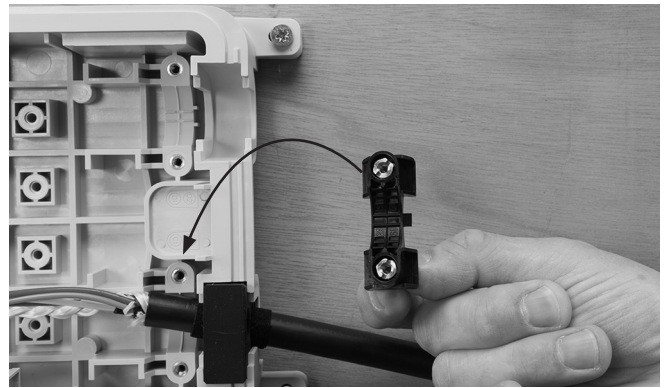

3.3.9 After having installed or removed the plastic shell, position the plastic bridge on top of the cable.

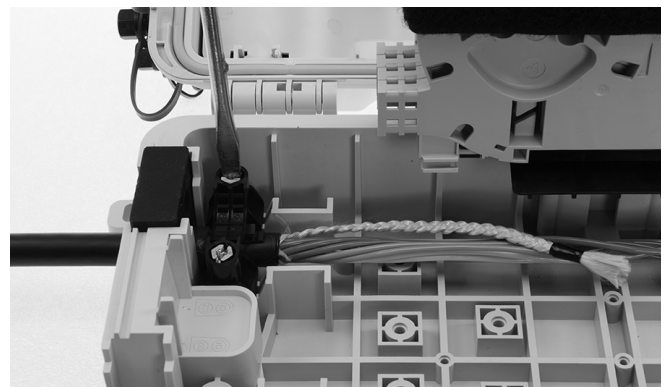

3.3.10 Secure the plastic bridge with the two metallic spacers. The cable jacket needs to protrude at least 2 mm (0.08 inch) from the plastic bridge.

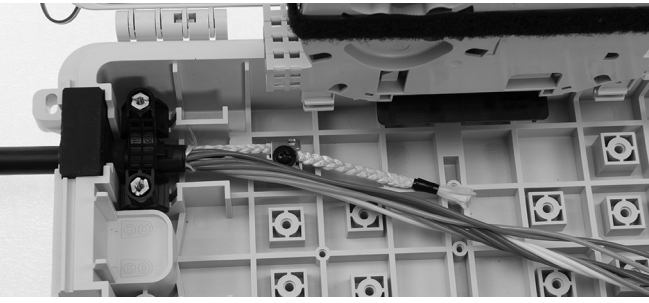

3.3.11 Tighten the aramid ponytail and secure it as shown in the image.

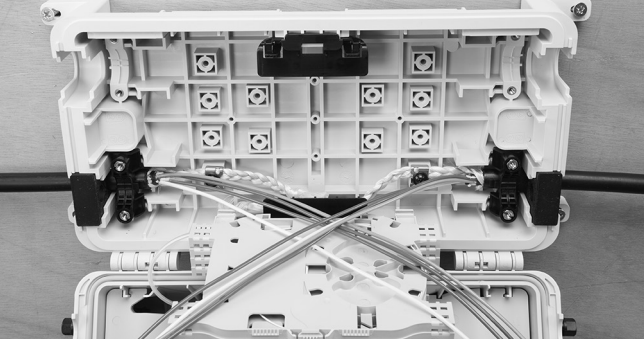

3.3.12 Feeder cables installed.

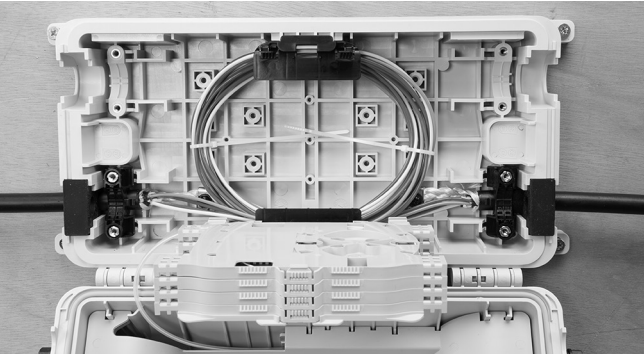

3.3.13 Store the loose tubes as shown.

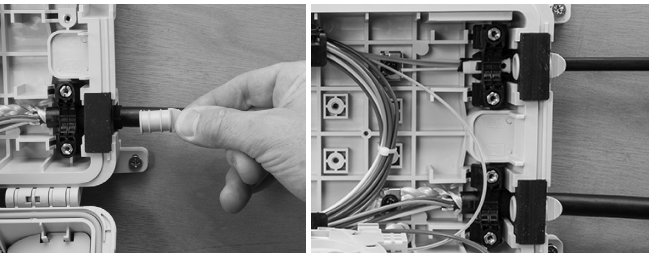

3.3.14 Install all of the blanking plugs in the ports that are not being used.

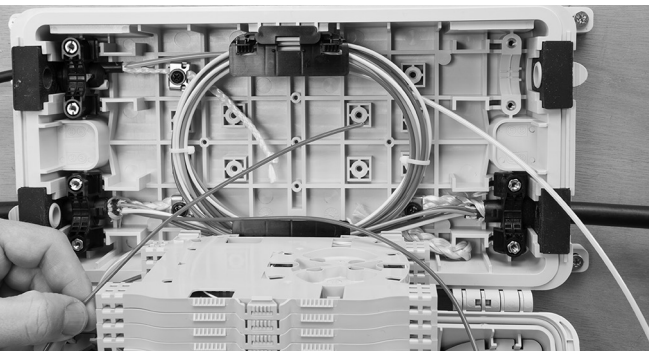

3.3.15 Cut the correct tube

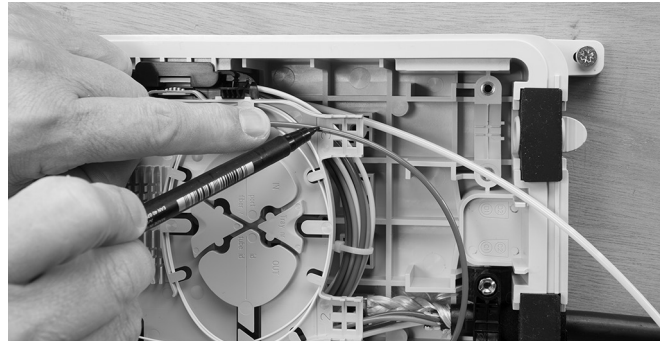

3.3.16 Route the tube towards the first tray (respecting the minimum bend radius of 30 mm (1.2 inch)). Mark as shown.



3.3.17 Wrap a piece of foam around the tube as shown.



3.3.18 Remove the excess tube and secure the end of the tube using cable ties as shown. Clean the fiber.

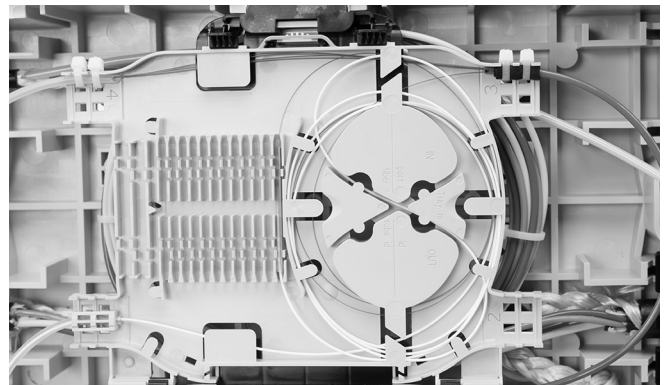

3.3.19 Splice the feeder fiber to the fiber of the splitter stored on tray 1. Store the SMOUV and the fiber over length per standard practice.

4 DROP CABLES

4.1 Stub cable Ø 11-16 mm (0.43-0.63 inch). (See procedure 3)

Please use the overview table for the use of the different components.

4.2 Round stub cable 7 mm (0.28 inch)

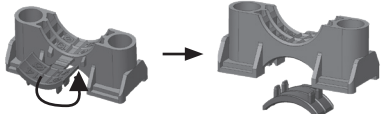
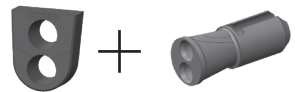
Cable zone(mm)	Cable type	Securing the cables	Sealing
Ø 7 (Ø 0,28")	TKT-8FO		

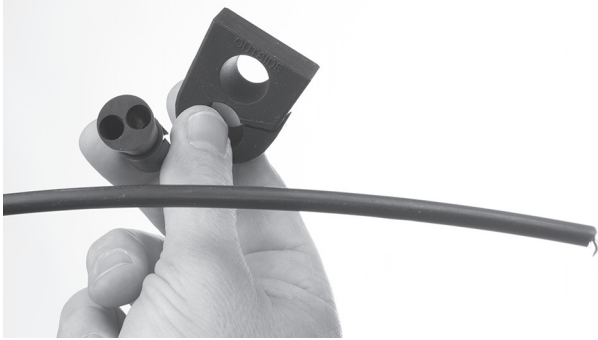

4.2.1 For round cables with a Ø of 7 mm (0.28 inch). Use the appropriate rubber seals as seen in the image.



4.2.2 Slide the rubber seal (valid for two small cables) over a length of 1.5 m (59 inch) of the cable.



4.2.3 Take the large seal and install it over the small seal. Lubricate the entire surface of the seal and the port before inserting it into the port.

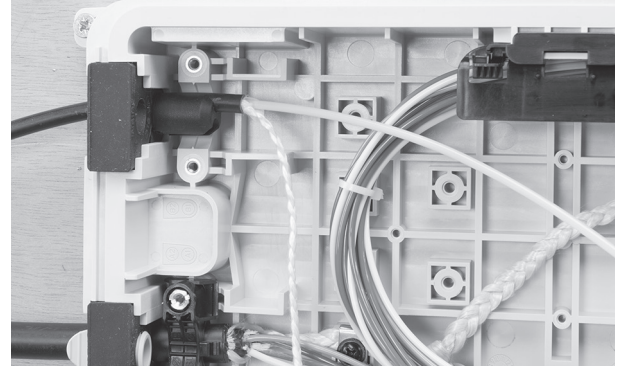

4.2.4 Remove the jacket, make a ponytail with the aramid yarn and install the assembly in the port. The cables must be positioned at the bottom and at the top of the port. They must never be positioned on the sides.

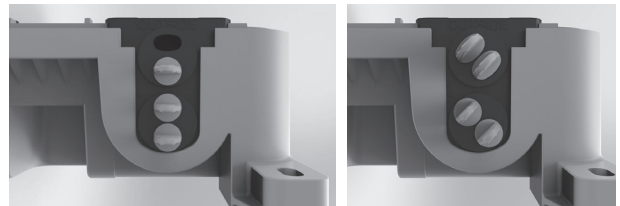

CORRECT

INCORRECT

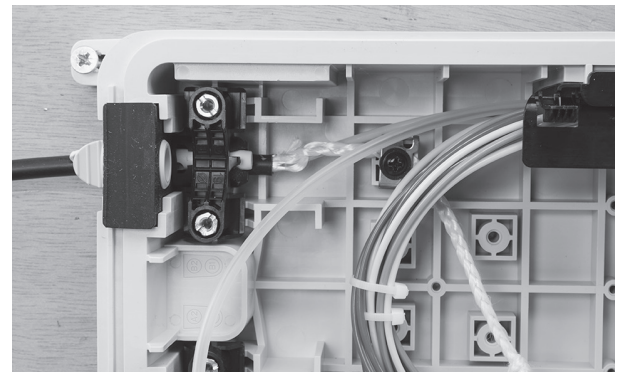

4.2.5 Install the blind plugs in the ports that are not being used. Tighten the aramid ponytail and secure it as shown. Install the shell on the plastic bridge. Secure the plastic bridge with the two metallic spacers. The cable jacket needs to protrude at least 2 mm (0.08 inch) from the plastic bridge.

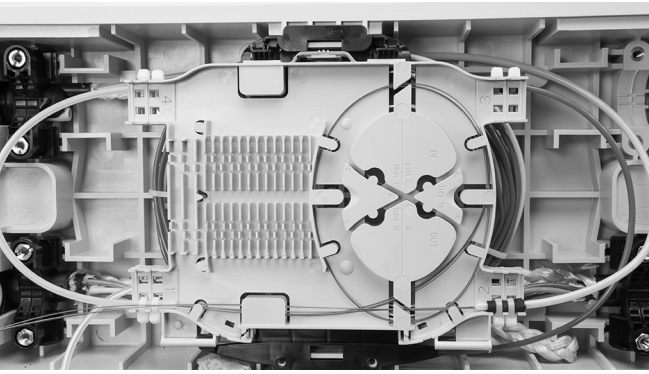

4.2.6 Route the tube towards the tray as shown, wrap a piece of foam around the tube, remove the excess tube and secure the tube end with cable ties.

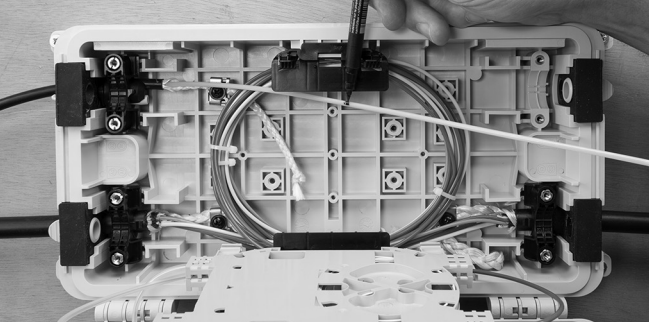

4.2.7 If the cable tube is very thick and or sensitive to bending, a transportation tube needs to be used. Make a mark on the tube as shown.

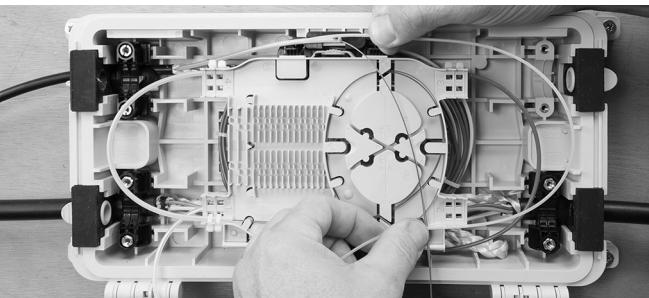

4.2.8 Remove the tube until the mark and clean the fibers properly. Use the transportation tube (30 cm - 11.8 inch).



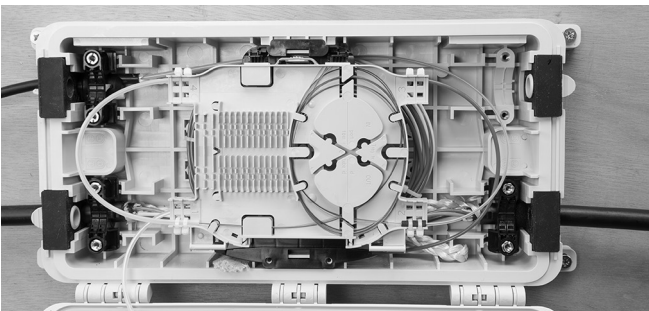

4.2.9 Insert the fibers into the transportation tube and push the transportation tube in or over the loose tube over a length of minimum 5 cm (2 inch).

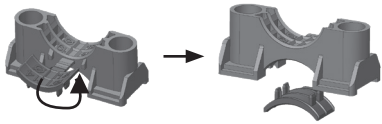

4.2.10 Secure the transportation tube to the tray using the foam and the cable ties as shown.

4.3 Flat drop cable

Cable zone	Cable type	Fixing of cables	Sealing
Flat cable	Flat cable 		

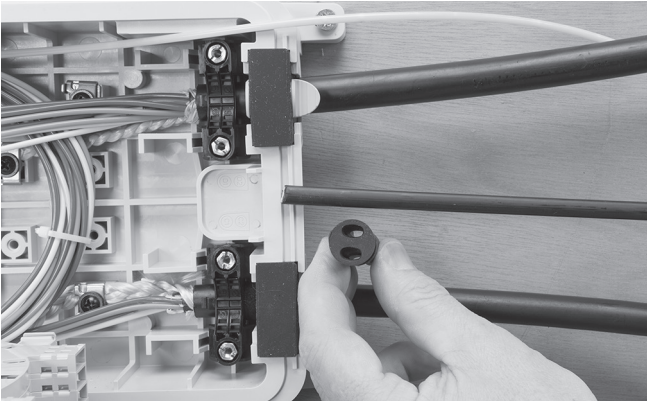

4.3.1 Follow the same procedure as used to install the 7 mm (0.28 inch) round cables to install the flat drop cables. Use the specific seal for two flat (oval) cables.

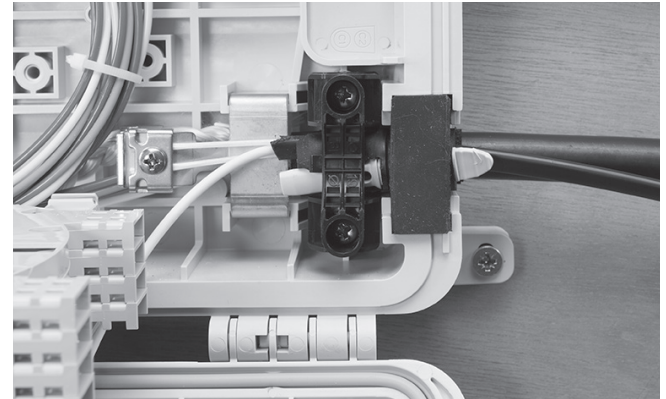

4.3.4 Install the blind plugs in the ports that are not being used. Secure the strength members. Install the shell on the plastic bridge. Secure the plastic bridge with the two metallic spacers. The cable jacket needs to protrude at least 2 mm (0.08 inch) from the plastic bridge.

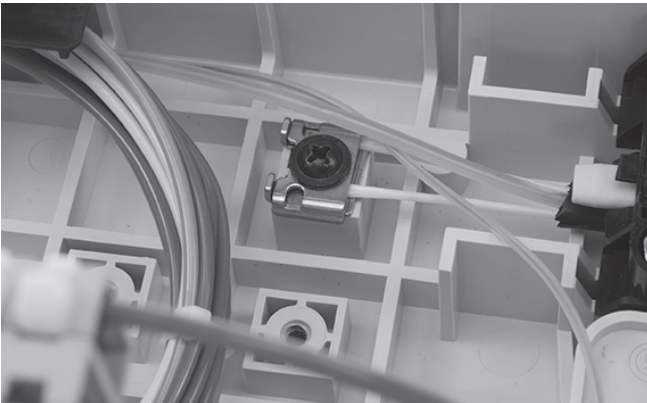

4.3.2 Secure the strength member as shown.

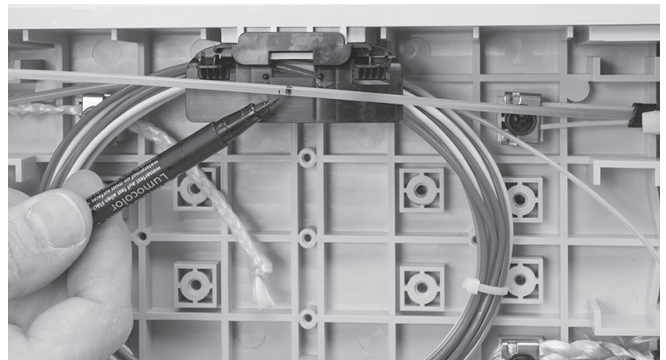

4.3.5 If the cable is very thick and or sensitive to bending, a transportation tube needs to be used. Make a mark as shown.

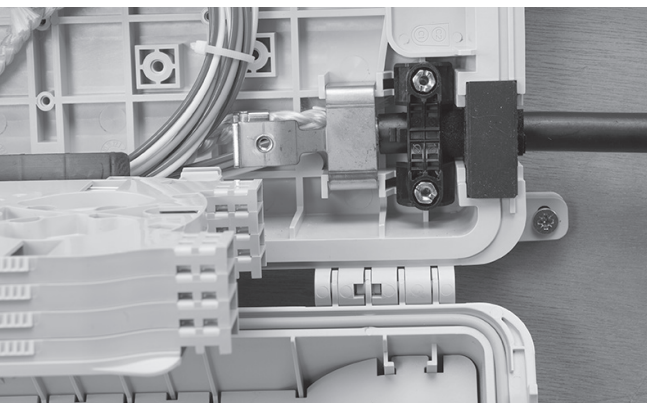

4.3.3 When the cable is installed in a top position, the strength member bracket should be used to secure the strength members.

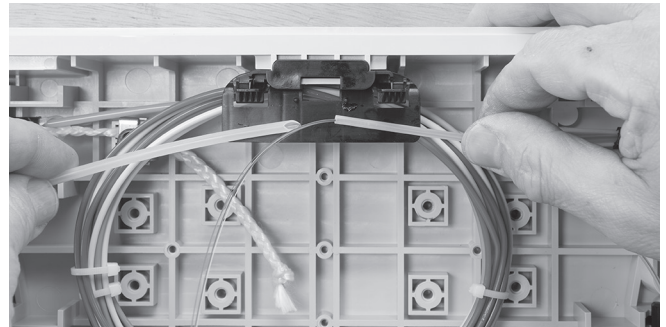

4.3.6 Remove the tube until the mark and clean the fibers properly.



4.3.7 Insert the fibers into the transportation tube.

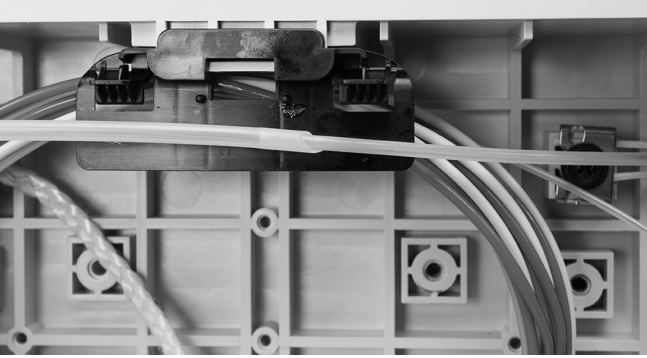

4.3.8 Push the transportation tube in or over the loose tube over a length of minimum 5 cm (2 inch). Avoid kinking.

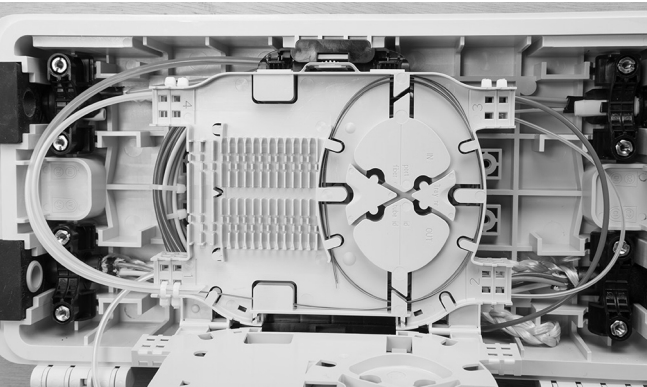

4.3.9 Secure the transportation tube to the tray using the foam and the cable ties as shown.

4.4 Installation of the second splitter

The second splitter is supplied pre-installed in a supplementary tray. It must be installed above the tower of 4 trays.

Remove the cover from the tray tower, assemble the new tray with the integrated splitter on top of the 4 trays.

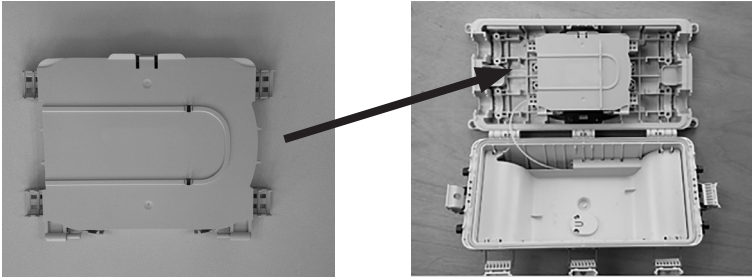

In order to splice the input fiber of the second splitter, this fiber is transported to tray 1 using a transportation tube. On tray 1, the input fiber can be spliced to the selected fiber of the feeder cable.

The output fibers of the second splitter can be spliced on the 5th tray to the fibers of drop cables.

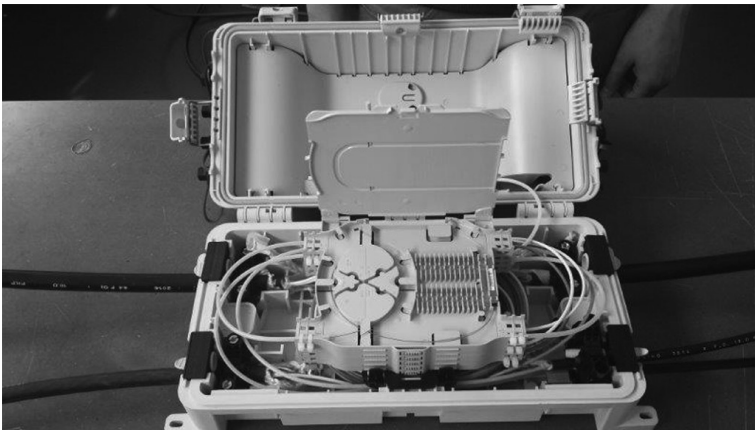
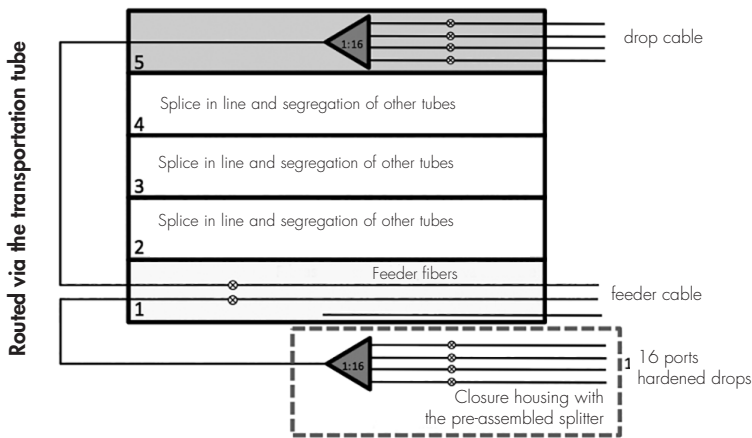

5 CLOSE THE CLOSURE

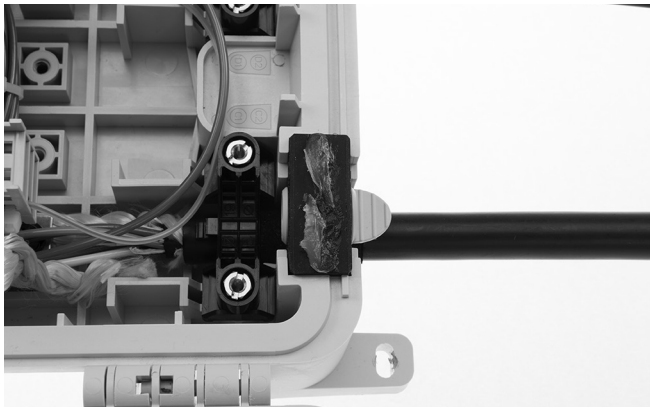
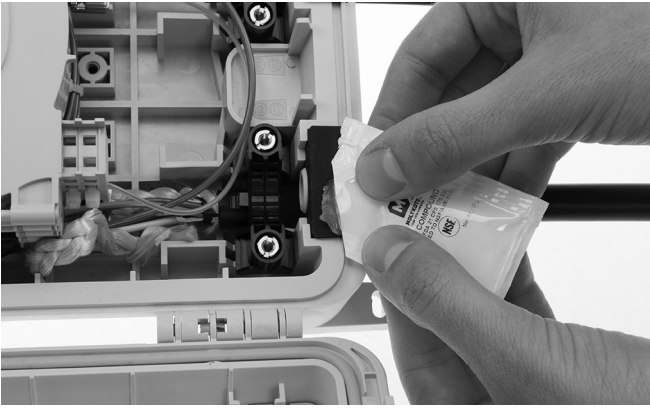

5.1 Lubricate the seals before closing the closure.

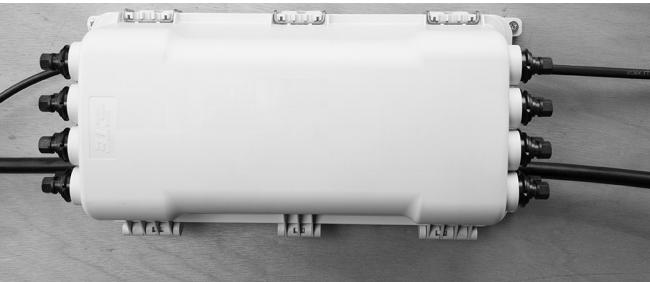

5.2 Close the 5 latches.

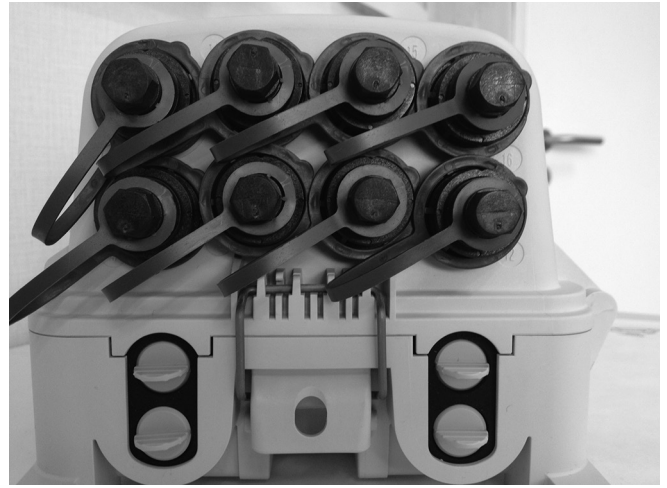

5.3 Ensure that all of the ports which are not being used are closed with their corresponding blind plugs.

To find out more about CommScope® products, visit us on the web at www.commscope.com

For technical assistance, customer service, or to report any missing/damaged parts, visit us at:
<http://www.commscope.com/SupportCenter>

© 2017 CommScope, Inc. All rights reserved.

SMOUV and all trademarks identified by ® or ™ are registered trademarks or trademarks, respectively, of CommScope, Inc.

This document is for planning purposes only and is not intended to modify or supplement any specifications or warranties relating to CommScope products or services.

This product is covered by one or more U.S. patents or their foreign equivalents. For patents, see:
www.commscope.com/ProductPatent/ProductPatent.aspx.