



TDUX - Inflatable Duct Seal, size 75

- Flexible and reliable wraparound inflatable sealing system for cables
- Fast and easy to install or remove, even when water is flowing out of the duct
- Independent of duct or cable ovality
- Water and airtight up to 50 kPa (7 psi)
- Environmentally friendly, non-toxic and resistant to chemicals

Product Classification

Regional Availability	Latin America North America
Product Type	Cable duct seal
Product Series	TDUX
Ordering Note	When sealing more than two cables in a duct, separate orderable TDUX-CL clips are to be used

Dimensions

Width	120 mm 4.724 in
Length	332 mm 13.071 in
Cable Diameter, maximum	56 mm 2.205 in
Cable Diameter, minimum	28 mm 1.102 in
Conduit Inner Diameter, maximum	75 mm 2.953 in
Conduit Inner Diameter, minimum	55 mm 2.165 in

Dimension Drawing

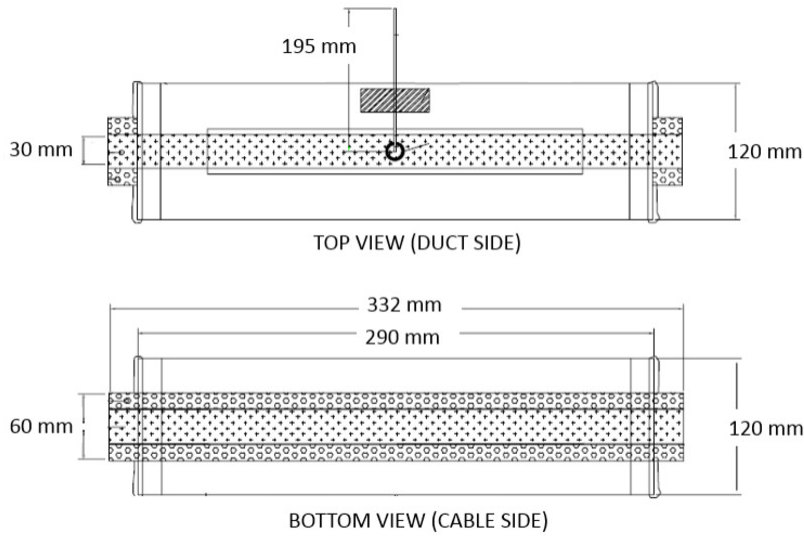

Environmental Specifications

Installation temperature -5 °C to +40 °C (+23 °F to +104 °F)

Packaging and Weights

Included Inflatable bladder with sealing mechanism

Packaging quantity 10

Regulatory Compliance/Certifications

Agency	Classification
CHINA-ROHS	Below maximum concentration value
REACH-SVHC	Compliant as per SVHC revision on www.commscope.com/ProductCompliance
ROHS	Compliant
UK-ROHS	Compliant

