

# Building entrance fiber boxes: BUDI portfolio

CommScope's BUDI portfolio of wall-mounted, indoor and outdoor fiber boxes is a modular and configurable platform for building entrance deployments. Available in a large variety of models to meet the needs of a wide range of MDU applications, it offers rugged environmental protection; is UL listed, UV resistant, and IP54 rated and is designed for easy installation and accessibility.

The CommScope BUDI family is ideal for small to medium size buildings. It provides a flexible fiber management system for transitioning outside plant cable to indoor cable via splicing or with connectorized cable assemblies. It incorporates proven fiber routing procedures, cable termination accessories and splice trays resulting in consistent, high-quality fiber management. Available add-on passive optical modules support the new G/EPON architecture. The BUDI portfolio offers the flexibility to address the needs of today's and tomorrow's fiber networks while maintaining commonality of components and operational practices.



BUDI-M-TS2FPS32N-0000  
with 4 ports

[Click for BUDI video](#)

## Features and benefits

- Indoor or indoor/outdoor (IP54) rugged termination point
- UL listed and UV resistant enclosure
- Wide range of cable size supported
  - Optional lockable accessory available
  - Drop cables up to 0.19-inch diameter, round or flat
  - Feeder cables up to 1.02-inch diameter
  - Protective cable skirts available
  - Wrap-around cable ports.
- Splice only and splice and patch versions
  - Fiber splicing using FOSC-A splice trays with optical splitters, taps, and C/DWDM capability
  - SC or LC connectors for patching
- Pre-terminated versions available
  - Indoor/outdoor riser cable with stranded or ribbon fiber
  - Available cable capacity with 24 or 48 fibers
  - Cable lengths up to 750 ft
- Splitter versions available
  - Plug-and-play FPS 1x32 and 1x64 modules supported
  - Splice 1x32 FOSC tray and pigtails installed
  - Additional ports available for pass-through fibers with plug-and-play versions
- Hardened terminal versions available
  - HMFOC flat drop cables preinstalled
  - Up to 48 fibers supported using slide adapter packs
  - Drop cable lengths up to 1,000 ft

## Specifications

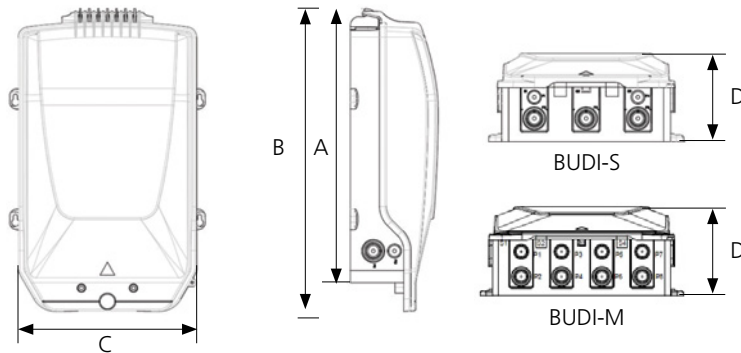

Dimensions	BUDI-S	BUDI-M
<b>A: Height (box)</b>	425 mm (16.73 in)	480 mm (18.9 in)
<b>B: Height (cover)</b>	500 mm (19.69 in)	550 mm (21.65 in)
<b>C: Width</b>	295 mm (11.61 in)	360 mm (14.17 in)
<b>D: Depth</b>	145 mm (5.71 in)	175 mm (6.89 in)

BUDI-FS-TS224-US00  
with 24-inch skirt and 3 ports



BUDI-FS-TS224-US00  
with 12-inch skirt and 3 ports



Splice and patch version  
with SC connectors



## View our installation videos

- [▶ BUDI with FOSC trays: Patch/Splice Installation and Cable Routing](#)
- [▶ BUDI with FOSC trays: Splice/Splice Installation and Cable Routing](#)

# Ordering information

## BUDI terminals with plug-and-play splitters

BUDI - M - T   FPS    -

### Connector type

S1	(SC/UPC)
S2	(SC/APC)

### Splitter type

NN	None installed
32	1x32
64	1x64

### Cable length

0000	0 ft
0300	300 ft
0500	500 ft
0750	750 ft
1000	1,000 ft

### Cable type

N	Splice only
G	24 Fiber indoor/outdoor OFNR RB

### Notes

- Second 1x32 FPS accessory kit can be added to achieve 1x64 total
- 1x32 and 1x64 FPS accessory kits are available separately for customization
- BUDI-M-FPS32-ACC (760245063) and BUDI-M-FPS64-ACC (760248012)



## BUDI with hardend terminals

BUDI - M - HMFOC - T     -

### Connector type

S1	(SC/UPC)
S2	(SC/APC)

### Number of adapters

12	12
24	24
36	36
48	48

### Cable length

US00	0 ft
0100	100 ft
0300	300 ft
0500	500 ft
0750	750 ft
1000	1,000 ft

### Notes

- 12 fiber flat drop cable with HMFOC (PLUG) non-pinned included for each cable
- 0ft HMFOC connectors are inside the box additional tether needed

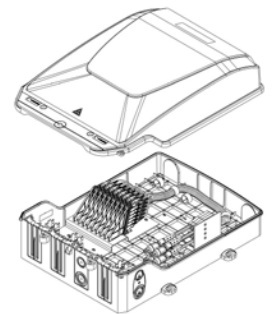

# Ordering information

## BUDI pre-term

BUDI -  - T      -

### BUDI size

S	BUDI-S
M	BUDI-M

### Connector type

S1	(SC/UPC)
S2	(SC/APC)
L1	(LC/UPC)
L2	(LC/APC)

### Number of adapters (see Notes)

24	24
48	48

### Cable length

0300	300 ft
0500	500 ft
0750	750 ft

### Cable type

F	24 and 48 Fiber Indoor/ outdoor OFNR STRD loose tube
G	24 and 48 Fiber Indoor/ outdoor OFNR RB

### Notes

- BUDI-S is limited to 24 adapters and the BUDI-M is limited to 48 adapters
- LC adapter are simplex type

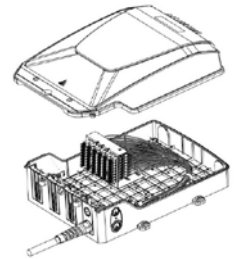

## BUDI terminals with FOSC trays

BUDI - F  - T     - US00

### BUDI size (see Notes)

S	BUDI-S
M	BUDI-M

### Connector type

S1	(SC/UPC)
S2	(SC/APC)
L1	(LC/UPC)
L2	(LC/APC)

### Number of adapters

12	12
24	24
36	36
48	48
72	72

### Notes

- BUDI-S is limited to 36 adapters and BUDI-M is limited to 72 adapters
- LC adapters are simplex type



# Additional configurations













Product	MID	Description
BUDI-SAJ32SA-MV	BUDI-SAJ32SA-MV	BUDI-S Splitter Terminal includes 1 feeder splice tray, 1 1x32 FPS PnP module, 32 SC/APC slide adapters installed
BUDI-SAJ32SM-MV	BUDI-SAJ32SM-MV	BUDI-S Splitter Terminal includes 1 feeder splice tray, 2 1x16 FPS PnP module, 32 SC/APC slide adapters installed
BUDI-FS-TS232-SPLTR	760243195	BUDI-S Splitter Terminal includes 1 FOSC tray, 1 1x32 splitter tray, 32 adapter/pigtail SC/APC installed
BUDI-1S-12M2-MP12	760238862	BUDI-1S Collector 12MPO adapters

## Ordering information and accessories

	Product	MID	Description
	BUDI-S-PTS-US00	760235991	Wrap-around pigtail seal for 48 pigtails with a diameter up to 5 mm (0.19 in)
	BUDI-S-SEAL-BLIND-PG29	760237400	Cable seal with a single cable gland for a cable from 15-26 mm (0.59-1.02 in)
	BUDI-S-SEAL-2x20	CS1390-000	Wrap-around cable seal for two cables up to 20 mm (0.79 in) diameter including: cable fixation bracket and seal foam tape
	BUDI-1S/S-2X25-US00	760243473	Wrap-around cable seal for two cables up to 25 mm (0.98 in) diameter including: cable fixation bracket and seal foam tape
	BUDI-M-2X25-US00	760243474	Wrap-around cable seal for two cables up to 25 mm (0.98 in) diameter including: cable fixation bracket and seal foam tape
	BUDI-S-4X15-US00	760236930	Wrap-around cable seal for four cables up to 15 mm (0.59 in) diameter including: cable fixation bracket and seal foam tape
	F-BENDCONTROL	760237456	Bend control system for splice applications
	F-BASKET-TOWER	760237455	Storage basket and tower for FOSC-A trays
	FOSC-ACC-A-tray-12- kit	497817-000	Includes tray, clear cover with (two) SM-6 splice modules, tie-wraps and instructions
	BUDI-S-SKRT-12	760238357	Protective metal cable skirt installed under the box to provide physical protection for the cable entering and exiting the box – 12 in length
	BUDI-S-SKRT-24	760238358	Protective metal cable skirt installed under the box to provide physical protection for the cable entering and exiting the box – 24 in length
	BUDI-FS 12/24 DEMARC COVER	760242703	Demarc accessory cover for BUDI-FS
	BUDI-M-SKRT-12-C-A	760240936	Protective metal cable skirt installed under the box to provide physical protection for the cable entering and exiting the box - 12 in length, c=closed bottom
	BUDI-M-SKRT-24-C-A	760240937	Protective metal cable skirt installed under the box to provide physical protection for the cable entering and exiting the box - 24 in length, c=closed bottom
	BUDI-M-SKRT-36-O-A	760240938	Protective metal cable skirt installed under the box to provide physical protection for the cable entering and exiting the box - 36 in length, o=open bottom. Accessory needed 760240981

For technical assistance, customer service, or to report any missing/damaged parts, visit us at [commscope.com/SupportCenter](https://commscope.com/SupportCenter).

## Ordering information and accessories

	Product	MID	Description
	F-BUDI-S-PAPAN-12	760238576	Bracket (and 2 screws), 12 adapters and 12 pigtails
	F-BUDI-S-PAPAN-24	760238577	Bracket (and 2 screws), 24 adapters and 24 pigtails
	BUDI-M-PTS	CV5903-000	BUDI-M Drop Cable Foam Seal Kit
	BUDI-M-SEAL-3X20	CS6979-000	Cable seal for 3 cables up to 20mm (0.79") diameter including: cable fixation bracket and seal foam tape
	BUDI-M-SEAL-6x15	CS6978-000	Cable seal for 6 cables up to 15mm (0.59") diameter including: cable fixation bracket and seal foam tape
	BUDI-M-ADPONLY-S2	760240983	24F SC/APC adapter kit
	BUDI-M-RBNPGTL-S2	760241003	24F singlemode SC/APC 12F ribbon pigtail (colorized) assembly kit
	BUDI-M-SKIRT-36-BTTM-KIT	760240981	Bottom Plate Kit for BUDI-M Metal Skirt, Includes three (3) 1.701/2.415: knockouts (to accommodate 1.25"/2.00" conduit).
	BUDI-M-SKIRT-15	760245233	BUDI-M Plastic Skirt, 15" L
	BUDI-M-SKIRT-36	760245234	BUDI-M Plastic Skirt, 36" L
	BUDI-M-DCORG-ACC	760245235	BUDI-M Drop Cable Organizer
	BUDI-FS 36 DEMARC COVER	760245897	Demarc accessory cover for BUDI-FS
	BUDI-S-COVER-KIT	760246212	BUDI-S Replacement Cover Kit
	BUDI-M-COVER-KIT	760246213	BUDI-M Replacement Cover Kit
	BUDI-M-FPS64-ACC	760248012	1x64 Splitter Module Kit, SC/APC
	BUDI-M-FPS32-ACC	760245063	1x32 Splitter Module Kit, SC/APC

For technical assistance, customer service, or to report any missing/damaged parts, visit us at [commscope.com/SupportCenter](https://commscope.com/SupportCenter).

CommScope pushes the boundaries of communications technology with game-changing ideas and ground-breaking discoveries that spark profound human achievement. We collaborate with our customers and partners to design, create and build the world's most advanced networks. It is our passion and commitment to identify the next opportunity and realize a better tomorrow. Discover more at [commscope.com](https://commscope.com).



---

[commscope.com](https://commscope.com)

Visit our website or contact your local CommScope representative for more information.

© 2020 CommScope, Inc. All rights reserved.

Unless otherwise noted, all trademarks identified by ® or ™ are registered trademarks or trademarks, respectively, of CommScope, Inc. This document is for planning purposes only and is not intended to modify or supplement any specifications or warranties relating to CommScope products or services. CommScope is committed to the highest standards of business integrity and environmental sustainability, with a number of CommScope's facilities across the globe certified in accordance with international standards, including ISO 9001, TL 9000, and ISO 14001. Further information regarding CommScope's commitment can be found at [www.commscope.com/About-Us/Corporate-Responsibility-and-Sustainability](https://www.commscope.com/About-Us/Corporate-Responsibility-and-Sustainability).

PA-1131734-EN (08/20)